

UNDER DEVELOPMENT

Features

- Ultra-Small Surface Mount Package
- Ideally suited for Automated Assembly Processes
- Very Sharp Breakdown Characteristics
- Very Tight Tolerance on Zener Breakdown Voltage

Mechanical Data

- Case: SOD-323, Plastic
- Case Material - UL Flammability Rating Classification 94V-0
- Moisture sensitivity: Level 1 per J-STD-020A
- Terminals: Solderable per MIL-STD-202, Method 208
- Polarity: Cathode Band
- Marking: Marking Code (See Table on Page 2)
- Weight: 0.004 grams (approx.)
- Ordering Information, See Below

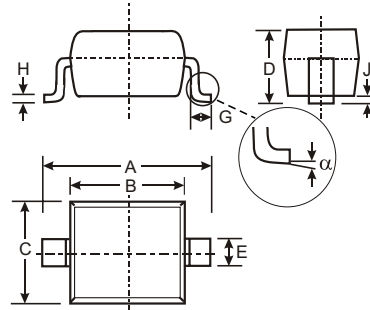

SOD-323		
Dim	Min	Max
A	2.30	2.70
B	1.60	1.80
C	1.20	1.40
D	1.05 Typical	
E	0.25	0.35
G	0.20	0.40
H	0.10	0.15
J	0.05 Typical	
α	0°	8°
All Dimensions in mm		

Maximum Ratings @ T_A = 25°C unless otherwise specified

Characteristic	Symbol	Value	Unit
Power Dissipation (Note 2)	P _d	200	mW
Thermal Resistance, Junction to Ambient Air (Note 2)	R _{θJA}	625	°C/W
Operating and Storage Temperature Range	T _j , T _{STG}	-65 to +150	°C

Ordering Information (Note 1)

Device	Packaging	Shipping
(Type Number)-7*	SOD-323	3000/Tape & Reel

* Add "-7" to the appropriate type number in Table 1 from Sheet 2 example: 6.2V Zener = UDZ6V2B-7.

- Notes:
1. For Packaging Details, go to our website at <http://www.diodes.com/datasheets/ap02007.pdf>.
 2. Part mounted on FR-4 PC board with recommended pad layout, which can be found on our website at <http://www.diodes.com/datasheets/ap02001.pdf>.

Marking Information



XX = Product Type Marking Code

Electrical Characteristics @ $T_A = 25^\circ\text{C}$ unless otherwise specified

Type Number	Marking Code	Zener Voltage Range (Note 3)			Maximum Zener Impedance (Note 4)			Maximum Reverse Current (Note 3)	
		$V_{ZT} @ I_{ZT}$		I_{ZT}	$Z_{ZT} @ I_{ZT}$	$Z_{ZK} @ I_{ZK}$	I_{ZK}	I_R	V_R
		Min (V)	Max (V)	mA	Ω		mA	μA	V
UDZ2V0B	B1	2.020	2.200	5	100	1000	0.5	120	0.5
UDZ2V2B	B2	2.220	2.410	5	100	1000	0.5	120	0.7
UDZ2V4B	B3	2.430	2.630	5	100	1000	0.5	120	1.0
UDZ2V7B	B4	2.690	2.910	5	110	1000	0.5	100	1.0
UDZ3V0B	B5	3.010	3.220	5	120	1000	0.5	50	1.0
UDZ3V3B	B6	3.320	3.530	5	120	1000	0.5	20	1.0
UDZ3V6B	B7	3.600	3.845	5	100	1000	1.0	10	1.0
UDZ3V9B	B8	3.890	4.160	5	100	1000	1.0	5	1.0
UDZ4V3B	B9	4.170	4.430	5	100	1000	1.0	5	1.0
UDZ4V7B	BA	4.550	4.750	5	100	800	0.5	2	1.0
UDZ5V1B	BB	4.980	5.200	5	80	500	0.5	2	1.5
UDZ5V6B	BC	5.490	5.730	5	60	200	0.5	1	2.5
UDZ6V2B	BD	6.060	6.330	5	60	100	0.5	1	3.0
UDZ6V8B	BE	6.650	6.930	5	40	60	0.5	0.5	3.5
UDZ7V5B	BF	7.280	7.600	5	30	60	0.5	0.5	4.0
UDZ8V2B	BG	8.020	8.360	5	30	60	0.5	0.5	5.0
UDZ9V1B	BH	8.850	9.230	5	30	60	0.5	0.5	6.0
UDZ10B	BI	9.770	10.210	5	30	60	0.5	0.1	7.0
UDZ11B	BJ	10.760	11.220	5	30	60	0.5	0.1	8.0
UDZ12B	BK	11.740	12.240	5	30	80	0.5	0.1	9.0
UDZ13B	BL	12.910	13.490	5	37	80	0.5	0.1	10.0
UDZ15B	BM	14.340	14.980	5	42	80	0.5	0.1	11.0
UDZ16B	BN	15.850	16.510	5	50	80	0.5	0.1	12.0
UDZ18B	BO	17.560	18.350	5	65	80	0.5	0.1	13.0
UDZ20B	BP	19.520	20.390	5	85	100	0.5	0.1	15.0
UDZ22B	BQ	21.540	22.470	5	100	100	0.5	0.1	17.0
UDZ24B	BR	23.720	24.780	5	120	120	0.5	0.1	19.0
UDZ27B	BS	26.190	27.530	5	150	150	0.5	0.1	21.0
UDZ30B	BT	29.190	30.690	5	200	200	0.5	0.1	23.0
UDZ33B	BU	32.150	33.790	5	250	250	0.5	0.1	25.0
UDZ36B	BV	35.070	36.870	5	300	300	0.5	0.1	27.0
UDZ39B	BW	38.025	39.975	5	300	350	0.5	0.1	29.0
UDZ43B	BX	41.925	44.075	2	300	400	0.5	0.1	32.0
UDZ47B	BY	45.825	48.175	2	300	450	0.5	0.1	35.0
UDZ51B	BZ	49.725	52.275	2	350	500	0.5	0.1	38.0
UDZ56B	U1	54.600	57.400	2	350	500	0.5	0.1	42.0

Notes: 3. Short duration test pulse used to minimize self-heating effect.

 4. The zener impedances (Z_{ZT} , Z_{ZK}) are measured by superimposing a minute alternating current on the regulated current (I_Z).

UNDER DEVELOPMENT

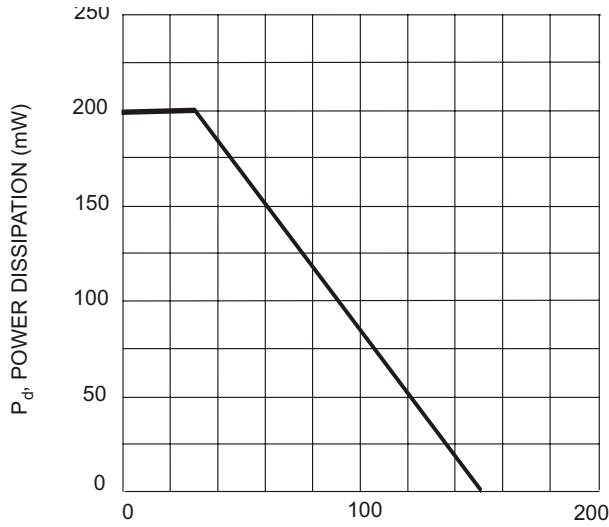

T_A , AMBIENT TEMPERATURE, (°C)

Fig. 1 Power Derating Curve

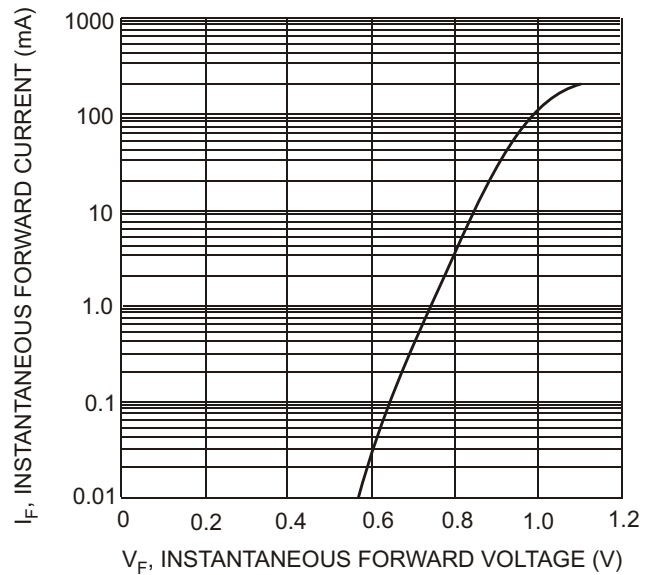

V_F , INSTANTANEOUS FORWARD VOLTAGE (V)

Fig. 2 Typical Forward Characteristics

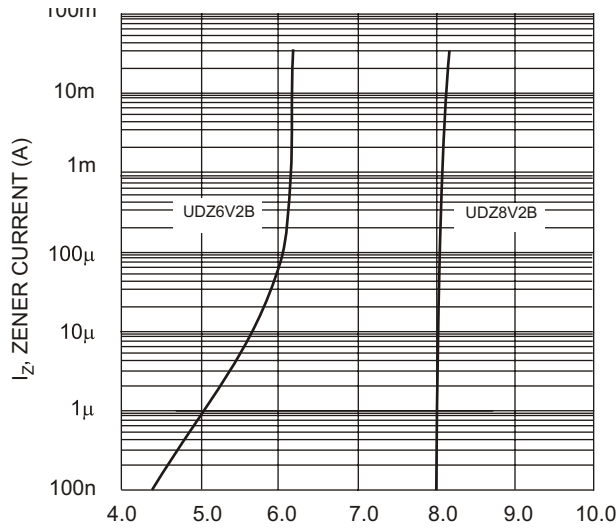

V_Z , ZENER BREAKDOWN VOLTAGE (V)

Fig. 3 Typical Reverse Characteristics, UDZ6V2B - UDZ8V2B

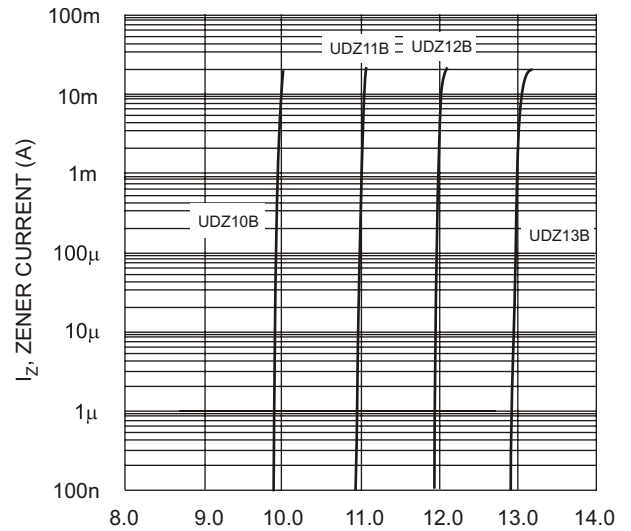

V_Z , ZENER BREAKDOWN VOLTAGE (V)

Fig. 4 Typical Reverse Characteristics, UDZ10B - UDZ13B

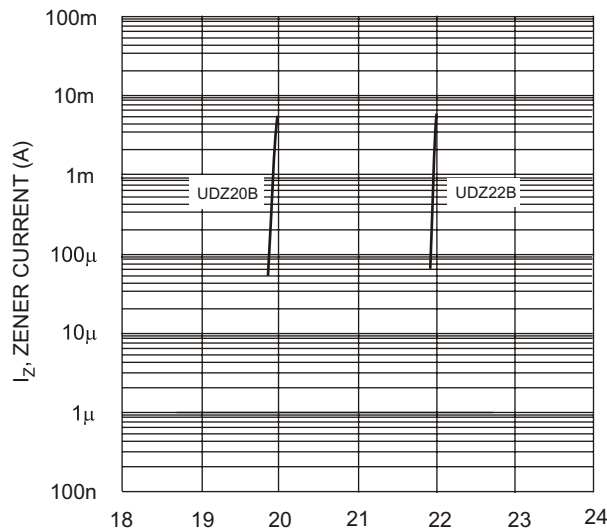

V_Z , ZENER BREAKDOWN VOLTAGE (V)

Fig. 5 Typical Reverse Characteristics, UDZ20B - UDZ22B

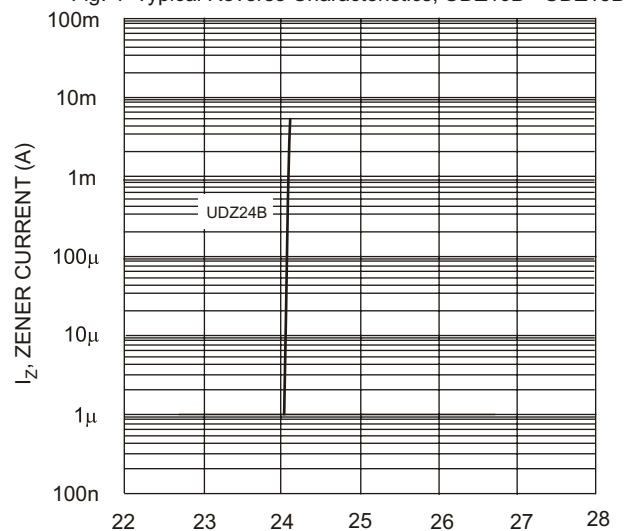

V_Z , ZENER BREAKDOWN VOLTAGE (V)

Fig. 6 Typical Reverse Characteristics, UDZ24B

UNDER DEVELOPMENT

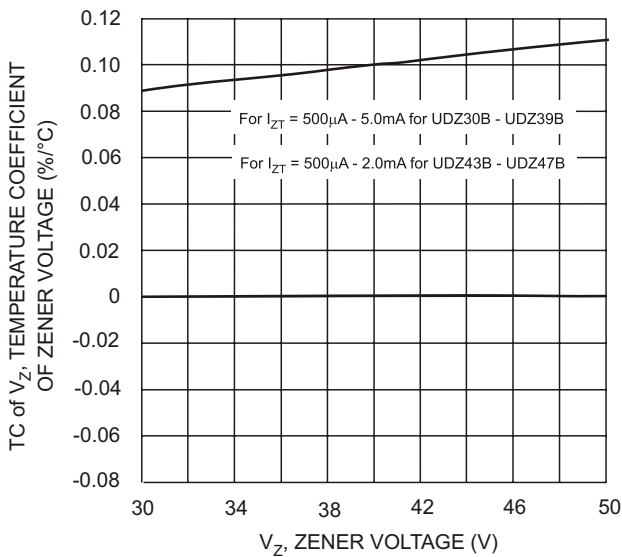
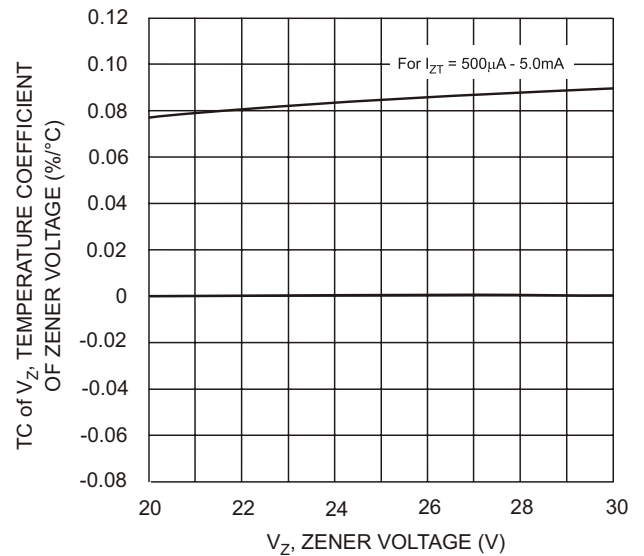
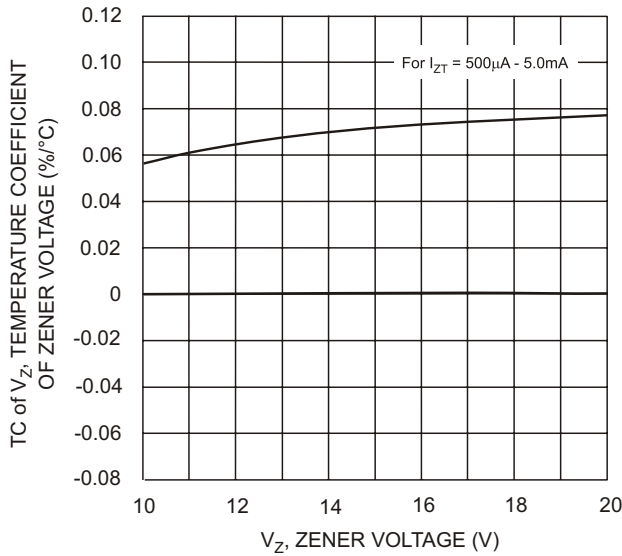
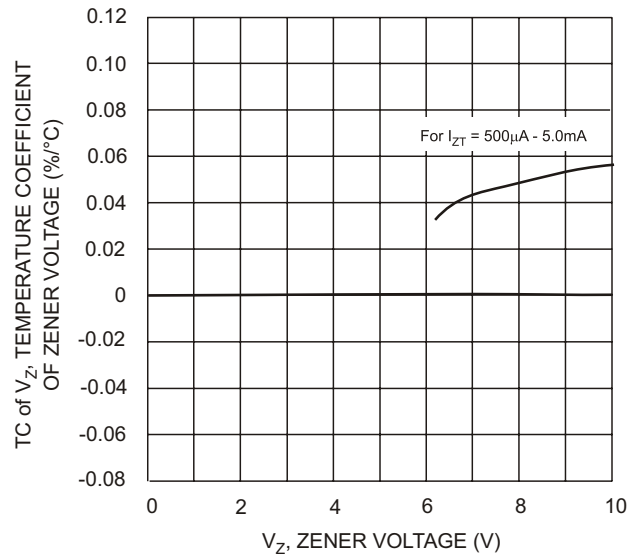
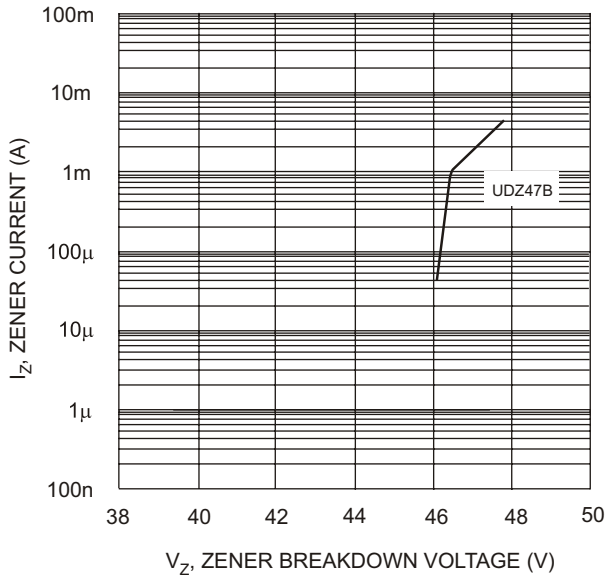

UNDER DEVELOPMENT

*Note: Additional Plots for Reverse Characteristics and Temperature Coefficient of Zener Voltage shall be available soon.