

FEATURES

- Fast read access time: 25 ns
- Pin compatible with the IS27C010
- High-speed write programming
 - Typically less than 30 seconds
- Industrial and commercial temperature ranges available
- 5V \pm 10% power supply tolerance
- JEDEC-approved pinout
- Standard 32-pin DIP, PLCC, and TSOP packages

DESCRIPTION

The *ISSI* IS27HC010 is an ultra-high-speed 1 megabit (128K-word by 8-bit) CMOS Programmable Read-Only Memory. It utilizes the standard JEDEC pinout making it functionally compatible with the IS27C010, but with significantly faster access capability. This superior random access capability results from a focused high-speed design. This offers users bipolar speeds with higher density, lower cost, and proven reliability.

The device is ideal for use with the faster processors. Designers may take full advantage of high-speed digital signal processors and microprocessors by allowing code to be executed at full speed directly out of EPROM. Typical applications include laser printers, switching networks, graphics, workstations, high-speed modems, and digital signal processing.

The IS27HC010 uses *ISSI's* write programming algorithm which allows the entire chip to be programmed in typically less than 30 seconds.

This product is available in One-Time Programmable (OTP) PDIP, PLCC, and TSOP packages over commercial and industrial temperature ranges.

FUNCTIONAL BLOCK DIAGRAM

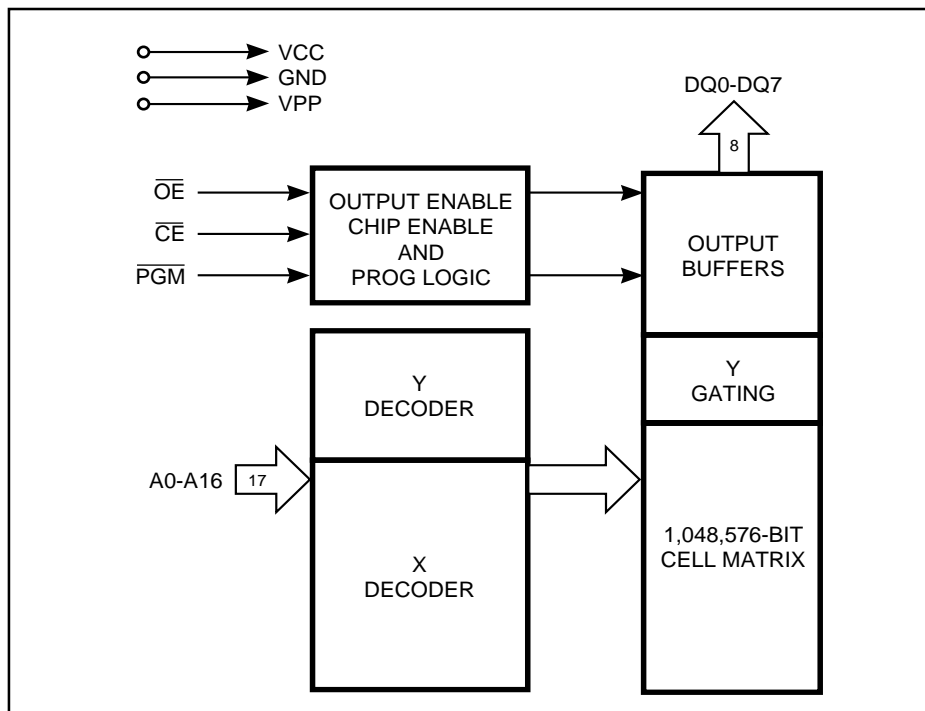

ISSI reserves the right to make changes to its products at any time without notice in order to improve design and supply the best possible product. We assume no responsibility for any errors which may appear in this publication. © Copyright 1997, Integrated Silicon Solution, Inc.

PIN CONFIGURATIONS

32-Pin DIP

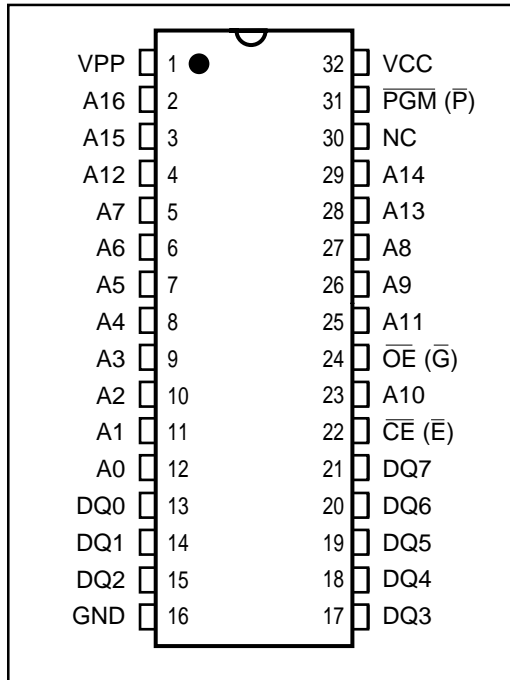

PIN DESCRIPTIONS

A0-A16	Address Inputs
\overline{CE} (\overline{E})	Chip Enable Input
DQ0-DQ7	Data Inputs/Outputs
\overline{OE} (\overline{G})	Output Enable Input
\overline{PGM} (\overline{P})	Program Enable Input
Vcc	Power Supply Voltage
VPP	Program Supply Voltage
GND	Ground
NC	No Internal Connection

32-Pin PLCC

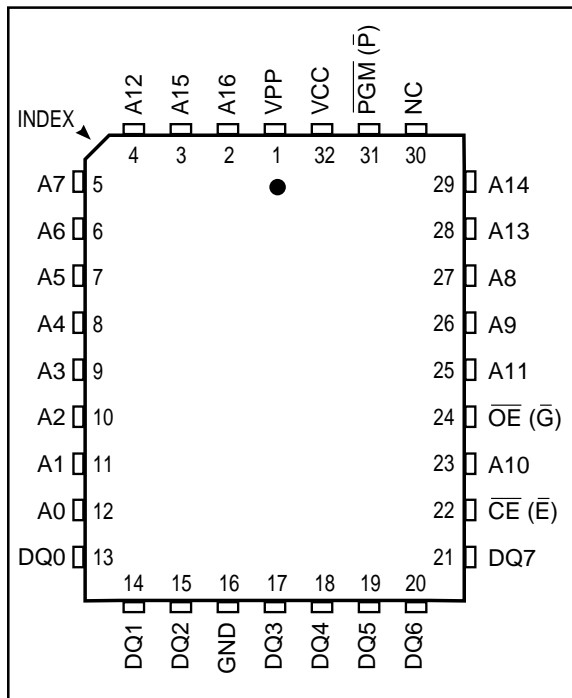

32-Pin TSOP

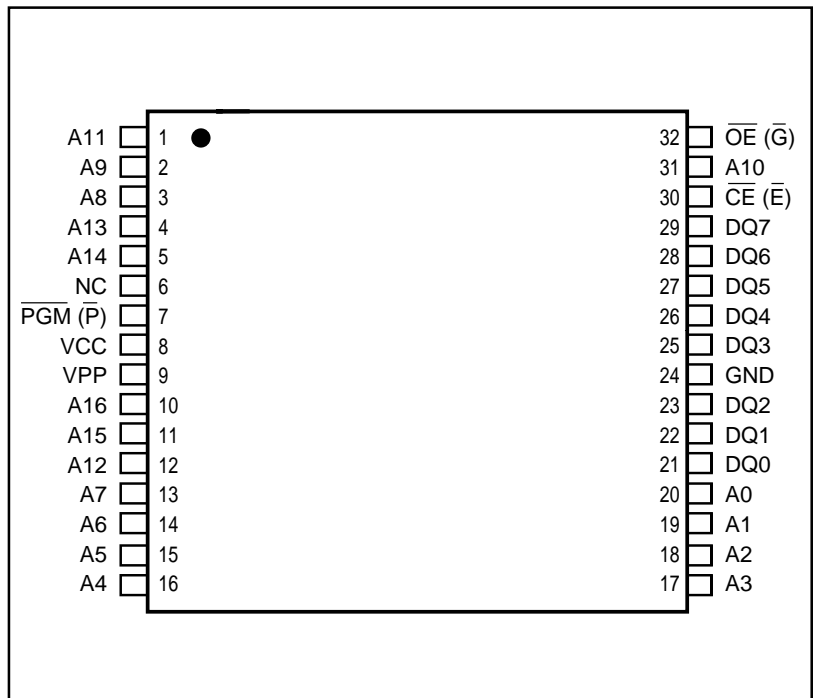

FUNCTIONAL DESCRIPTION

Programming the IS27HC010

Upon delivery, the IS27HC010 has 1,048,576 bits in the "ONE", or HIGH state. "ZEROS" are loaded into the IS27HC010 through the procedure of programming.

The programming mode is entered when $12.5 \pm 0.25V$ is applied to the V_{PP} pin, $V_{CC} = 6V$, \overline{CE} and \overline{PGM} is at V_{IL} , and \overline{OE} is at V_{IH} . For programming, the data to be programmed is applied eight bits in parallel to the data output pins.

The write programming algorithm reduces programming time by using 100 μs programming pulses followed by a byte verification to determine whether the byte has been successfully programmed. If the data does not verify, an additional pulse is applied for a maximum of 25 pulses. This process is repeated while sequencing through each address of the EPROM.

The write programming algorithm programs and verifies at $V_{CC} = 6V$ and $V_{PP} = 12.5V$. After the final address is completed, all byte are compared to the original data with $V_{CC} = 5.25V$.

Program Inhibit

Programming of multiple IS27HC010s in parallel with different data is also easily accomplished. Except for \overline{CE} , all like inputs of the parallel IS27HC010 may be common. A TTL low-level program pulse applied to an IS27HC010 \overline{CE} input with $V_{PP} = 12.5 \pm 0.25V$, \overline{PGM} LOW and \overline{OE} HIGH will program that IS27HC010. A high-level \overline{CE} input inhibits the other IS27HC010 from being programmed.

Program Verify

A verify should be performed on the programmed bits to determine that they were correctly programmed. The verify should be performed with \overline{OE} and \overline{CE} at V_{IL} , \overline{PGM} at V_{IH} , and V_{PP} between 12.25V and 12.75V.

Auto Select Mode

The auto select mode allows the reading out of a binary code from an EPROM that will identify its manufacturer and type. This mode is intended for use by programming equipment for the purpose of automatically matching the device to be programmed with its corresponding programming algorithm. This mode is functional in the $25^{\circ}C \pm 5^{\circ}C$ ambient temperature range that is required when programming the IS27HC010.

To activate this mode, the programming equipment must force $12.0 \pm 0.5V$ on address line A9 of the IS27HC010. Two identifier bytes may then be sequenced from the device outputs by toggling address line A0 from V_{IL} to V_{IH} .

All other address lines must be held at V_{IL} during auto select mode.

Byte 0 ($A0 = V_{IL}$) represents the manufacturer code, and byte 1 ($A0 = V_{IH}$), the device identifier code. For the IS27HC010, these two identifier bytes are given in the Mode Select table. All identifiers manufacturer and device codes will possess odd parity, with the MSB (DQ7) defined as the parity bit.

Read Mode

The IS27HC010 has two control functions, both of which must be logically satisfied in order to obtain data at the outputs. Chip Enable (\overline{CE}) is the power control and should be used for device selection. Assuming that addresses are stable, address access time (t_{ACC}) is equal to the delay from \overline{CE} to output (t_{CE}). Output Enable (\overline{OE}) is the output control and should be used to get data to the output pins, independent of device selection. Data is available at the outputs t_{OE} after the falling edge of \overline{OE} assuming that \overline{CE} has been LOW and addresses have been stable for at least $t_{ACC} - t_{OE}$.

Standby Mode

The IS27HC010 has a standby mode which reduces the maximum V_{CC} active current. It is placed in standby mode when \overline{CE} is at V_{IH} . The amount of current drawn in standby mode depends on the frequency and the number of address pins switching. The IS27HC010 is specified with 50% of the address lines toggling at 10 MHz. A reduction of the frequency or quantity of address lines toggling will significantly reduce the actual standby current.

Output OR-Tieing

To accommodate multiple memory connections, a two-line control function is provided to allow for:

1. Low memory power dissipation, and
2. Assurance that output bus contention will not occur.

It is recommended that \overline{CE} be decoded and used as the primary device-selecting function, while \overline{OE} be made a common connection to all devices in the array and connected to the READ line from the system control bus. This assures that all deselected memory devices are in their low-power standby mode and that the output pins are only active when data is desired from a particular memory device.

System Applications

During the switch between active and standby conditions, transient current peaks are produced on the rising and falling edges of Chip Enable. The magnitude of these transient current peaks is dependent on the output capacitance loading of the device at a minimum, a 0.1 μF ceramic capacitor (high-frequency, low inherent inductance) should be used on each device between V_{CC} and GND to minimize transient effects. In addition, to overcome the voltage drop caused by the inductive effects of the printed circuit board traces on EPROM arrays, a 4.7 μF bulk electrolytic capacitor should be used between V_{CC} and GND for each eight devices. The location of the capacitor should be close to where the power supply is connected to the array.

TRUTH TABLE^(1,2)

Mode	\overline{CE}	\overline{OE}	\overline{PGM}	A0	A9	V_{PP}	Outputs
Read	V_{IL}	V_{IL}	X	X	X	V_{CC}	DOUT
Output Disable	V_{IL}	V_{IH}	X	X	X	V_{CC}	Hi-Z
Standby	V_{IH}	X	X	X	X	V_{CC}	Hi-Z
Program	V_{IL}	V_{IH}	V_{IL}	X	X	V_{PP}	DIN
Program Verify	V_{IL}	V_{IL}	V_{IH}	X	X	V_{PP}	DOUT
Program Inhibit	V_{IH}	X	X	X	X	V_{PP}	Hi-Z
Auto Select ^(3,5)	Manufacturer Code	V_{IL}	X	V_{IL}	V_{H}	V_{CC}	D5H
	Device Code	V_{IL}	X	V_{IH}	V_{H}	V_{CC}	0EH

Notes:

1. $V_{H} = 12.0V \pm 0.5V$.
2. X = Either V_{IH} or V_{IL} .
3. A1-A8 = A10-A16 = V_{IL} .
4. See DC Programming Characteristics for V_{PP} voltage during programming.
5. The IS27HC010 can use the same write algorithm during program as other IS27C010 or IS27010 devices.

LOGIC SYMBOL

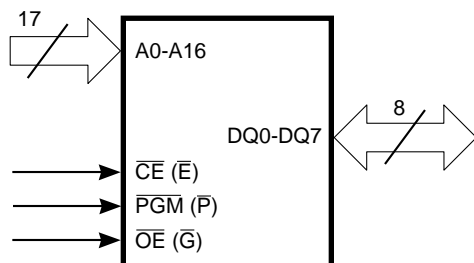

ABSOLUTE MAXIMUM RATINGS⁽¹⁾

Symbol	Parameter	Value	Unit
V _{TERM}	Terminal Voltage with Respect to GND		
	All pins except A9 and V _{PP}	-0.6 to V _{CC} + 0.5 ⁽²⁾	V
	V _{PP}	V _{CC} - 0.3 to 13.5 ^(2,3)	V
	A9	-0.6 to 13.5 ^(2,3)	V
	V _{CC}	-0.6 to 7.0 ⁽²⁾	V
T _A	Ambient Temperature with Power Applied	-65 to +125	°C
T _{STG}	Storage Temperature (OTP)	-65 to +125	°C
T _{STG}	Storage Temperature (All others)	-65 to +150	°C

Notes:

1. Stress greater than those listed under ABSOLUTE MAXIMUM RATINGS may cause permanent damage to the device. This is a stress rating only and functional operation of the device at these or any other conditions above those indicated in the operational sections of this specification is not implied. Exposure to absolute maximum rating conditions for extended periods may affect reliability.
2. Minimum DC input voltage is -0.5V. During transitions, inputs may undershoot to -2.0V for periods less than 10 ns. Maximum DC voltage on output pins is V_{CC} + 0.5V which may overshoot to V_{CC} + 2.0V for periods less than 10 ns.
3. Maximum DC voltage on A9 or V_{PP} may overshoot to +13.5V for periods less than 10 ns.

OPERATING RANGE

Range	Ambient Temperature	V _{CC}
Commercial	0°C to +70°C	5V ± 10%
Industrial ⁽¹⁾	-40°C to +85°C	5V ± 10%

Note:

1. Operating ranges define those limits between which the functionality of the device is guaranteed.

DC ELECTRICAL CHARACTERISTICS^(1,2,3) (Over Operating Range)

Symbol	Parameter	Test Conditions	Min.	Max.	Unit
V _{OH}	Output HIGH Voltage	V _{CC} = Min., I _{OH} = -4 mA	2.4	—	V
V _{OL}	Output LOW Voltage	V _{CC} = Min., I _{OL} = 12 mA	—	0.45	V
V _{IH}	Input HIGH Voltage ⁽⁴⁾		2.0	V _{CC} + 0.5	V
V _{IL}	Input LOW Voltage ⁽⁴⁾		-0.3	0.8	V
I _{LI}	Input Load Current	V _{IN} = 0V to +V _{CC}	—	5.0	μA
I _{LO}	Output Leakage Current	V _{OUT} = 0V to +V _{CC}	—	10	μA

Notes:

1. V_{CC} must be applied simultaneously or before V_{PP} and removed simultaneously or after V_{PP}. Never try to force V_{PP} LOW to 1V below V_{CC}. Manufacturer suggests to tie V_{PP} and V_{CC} together during the READ operation.
2. **Caution:** the IS27HC010 must not be removed from (or inserted into) a socket when V_{CC} or V_{PP} is applied.
3. Minimum DC input voltage is -0.5V. During transitions, the inputs may undershoot to -2.0V for periods less than 10 ns. Maximum DC voltage on output pins is V_{CC} + 0.5V which may overshoot to V_{CC} + 2.0V for periods less than 10 ns.
4. Tested under static DC conditions.

POWER SUPPLY CHARACTERISTICS^(1,2,5) (Over Operating Range)

Symbol	Parameter	Test Conditions	Min.	Max.	Unit
I _{CC1}	V _{CC} Operating Supply Current ⁽³⁾	V _{CC} = Max., $\overline{CE} = V_{IL}$ I _{OUT} = 0 mA, f = 10 MHz (Open outputs)	Commercial Industrial	— 30 40	mA
I _{PP1}	V _{PP} Current During Read ⁽⁴⁾	V _{CC} = Max., $\overline{CE} = \overline{OE} = V_{IL}$ V _{PP} = V _{CC}		— 100	μA
I _{CCSB0}	V _{CC} CMOS Standby Current	$\overline{CE} \geq V_{CC} - 0.3V$ All pins $\geq V_{CC} - 0.3V$ or $\leq 0.3V$		— 50	μA
I _{CCSB1}	V _{CC} TTL Standby Current	$\overline{CE} \geq V_{IH}$ All pins = V _{IH} or V _{IL} (TTL Level)		— 1	mA

Notes:

- V_{CC} must be applied simultaneously or before V_{PP} and removed simultaneously or after V_{PP}. Never try to force V_{PP} LOW to 1V below V_{CC}. Manufacturer suggests to tie V_{PP} and V_{CC} together during the READ operation.
- Caution:** the IS27HC010 must not be removed from (or inserted into) a socket when V_{CC} or V_{PP} is applied.
- I_{CC1} is tested with $\overline{OE} = V_{IH}$ to simulate open outputs.
- Maximum active power usage is the sum of I_{CC} and I_{PP}.
- Minimum DC input voltage is -0.5V. During transitions, the inputs may undershoot to -2.0V for periods less than 10 ns. Maximum DC voltage on output pins is V_{CC} + 0.5V which may overshoot to V_{CC} + 2.0V for periods less than 10 ns.

CAPACITANCE^(1,2,3)

Symbol	Parameter	Conditions	DIP		PLCC/T SOP		Unit
			Typ.	Max.	Typ.	Max.	
C _{IN1}	Address Input Capacitance	V _{IN} = 0V	6	10	6	9	pF
C _{IN2}	\overline{OE} Input Capacitance	V _{IN} = 0V	10	10	7	9	pF
C _{IN3}	\overline{CE} Input Capacitance	V _{IN} = 0V	10	10	7	9	pF
C _{OUT}	Output Capacitance	V _{OUT} = 0V	8	12	6	9	pF

Notes:

- Typical values are for nominal supply voltage.
- This parameter is only sampled, but not 100% tested.
- Test conditions: T_A = 25°C, f = 1 MHz.

SWITCHING TEST CIRCUIT

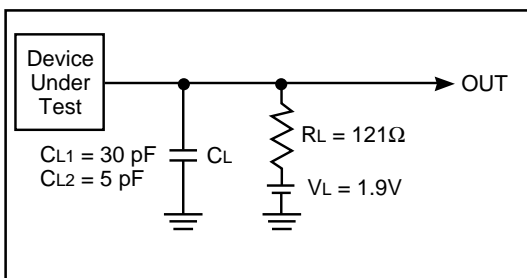

SWITCHING TEST WAVEFORM

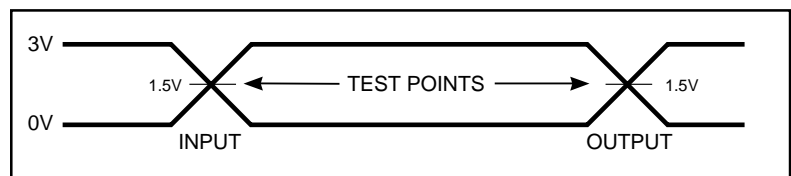

Notes:

AC Testing:

- Inputs are driven at 3.0V for a logic "1" and 0V for a logic "0".
- Input pulse rise and fall skew rate $\geq 1.5V/ns$.

SWITCHING CHARACTERISTICS^(1,3,4) (Over Operating Range)

JEDEC Symbol	Std. Symbol	Parameter	Test Conditions	-25		-30		-45		-70		Unit
				Min.	Max.	Min.	Max.	Min.	Max.	Min.	Max.	
t _{AVQA}	t _{ACC}	Address to Output Delay	$\overline{CE} = \overline{OE} = V_{IL}$ C _L = C _{L1}	—	25	—	30	—	45	—	70	ns
t _{ELQV}	t _{CE}	Chip Enable to Output Delay	$\overline{OE} = V_{IL}$ C _L = C _{L1}	—	25	—	30	—	45	—	70	ns
t _{GLQV}	t _{OE}	Output Enable to Output Delay	$\overline{CE} = V_{IL}$ C _L = C _{L1}	—	10	—	10	—	20	—	35	ns
t _{EHQZ} , t _{GHQZ}	t _{DF} ⁽²⁾	Chip Enable HIGH or Output Enable HIGH, whichever comes first, to Output Float	C _L = C _{L2}	0	10	0	10	0	20	0	35	ns
t _{AVOX}	t _{OH}	Output Hold from Address, \overline{CE} or \overline{OE} whichever occurred first		0	—	0	—	0	—	0	—	ns

Notes:

- V_{CC} must be applied simultaneously or before V_{PP} and removed simultaneously or after V_{PP}.
- This parameter is only sampled, not 100% tested.
- Caution:** The IS27HC010 must not be removed from (or inserted into) a socket or board when V_{PP} or V_{CC} applied.
- Output Load: 1 TTL gate and C = C_L.
Input Rise and Fall times: 2 ns.
Input Pulse Levels: 0 to 3V.
Timing Measurement Reference Level: 1.5V for inputs and outputs.

SWITCHING WAVEFORMS

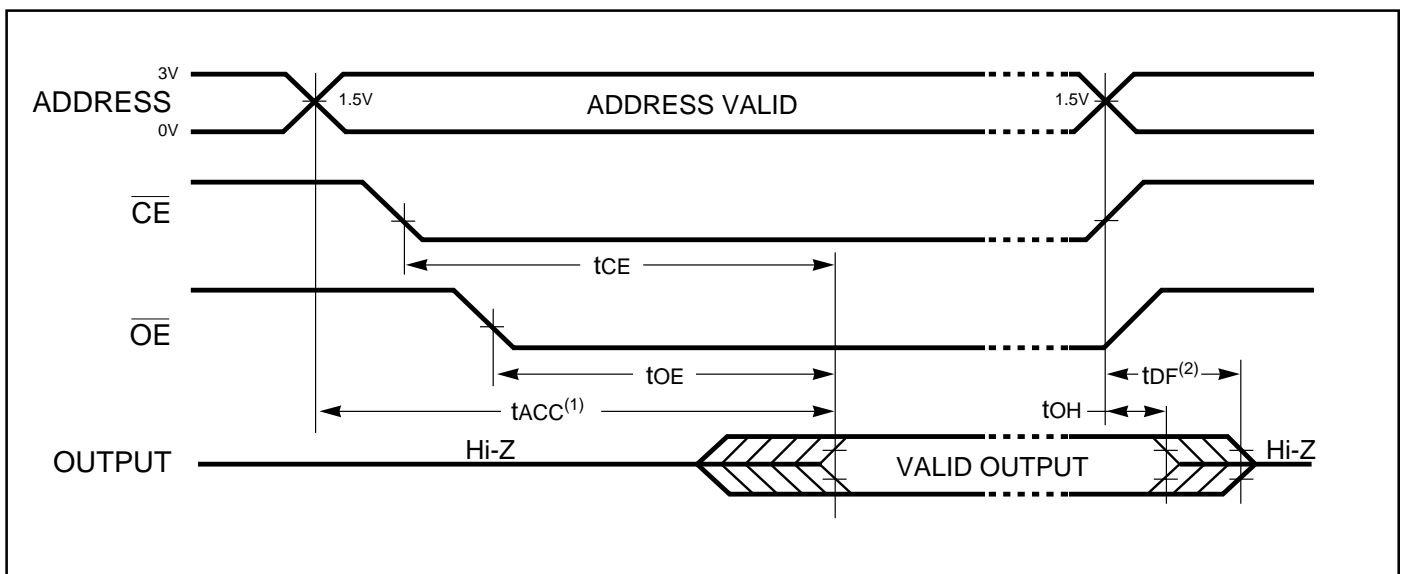

Notes:

- \overline{OE} may be delayed up to t_{ACC} – t_{OE} after the falling edge of \overline{CE} without impact on t_{ACC}.
- t_{DF} is specified from \overline{OE} or \overline{CE} , whichever occurs first.

DC PROGRAMMING CHARACTERISTICS^(1,2,3,4) ($T_A = +25^\circ\text{C} \pm 5^\circ\text{C}$)

Symbol	Parameter	Test Conditions	Min.	Max.	Unit
V _{OH}	Output HIGH Voltage During Verify	I _{OH} = -400 μ A	2.4	—	V
V _{OL}	Output LOW Voltage During Verify	I _{OL} = 2.1 mA	—	0.45	V
V _{IH}	Input HIGH Voltage		2.0	V _{CC} + 0.5	V
V _{IL}	Input LOW Voltage (All Inputs)		-0.3	0.8	V
V _H	A9 Auto Select Voltage		11.5	12.5	V
I _{LI}	Input Current (All Inputs)	V _{IN} = V _{IL} or V _{IH}	—	10.0	μ A
I _{CC}	V _{CC} Supply Current (Program & Verify)		—	50	mA
I _{PP}	V _{PP} Supply Current	$\overline{\text{CE}} = \text{VIL}, \overline{\text{OE}} = \text{VIH}$	—	30	mA
V _{CC}	Supply Voltage		5.75	6.25	V
V _{PP}	Programming Voltage		12.25	12.75	V

SWITCH PROGRAMMING CHARACTERISTICS^(1,2,3,4) ($T_A = +25^\circ\text{C} \pm 5^\circ\text{C}$)

JEDEC Symbol	Std. Symbol	Parameter	Min.	Max.	Unit
t _{AVEL}	t _{AS}	Address Setup Time	2	—	μ s
t _{DZGL}	t _{OES}	$\overline{\text{OE}}$ Setup Time	2	—	μ s
t _{DVEL}	t _{DS}	Data Setup Time	2	—	μ s
t _{GHAX}	t _{AH}	Address Hold Time	0	—	μ s
t _{EHDX}	t _{DH}	Data Hold Time	2	—	μ s
t _{GHQZ}	t _{DFP}	$\overline{\text{OE}}$ HIGH to Output Float Delay	0	130	ns
t _{VPS}	t _{VPS}	V _{PP} Setup Time	2	—	μ s
t _{ELEH1}	t _{PW}	$\overline{\text{PGM}}$ Program Pulse Width	95	105	μ s
t _{VCS}	t _{VCS}	V _{CC} Setup Time	2	—	μ s
t _{ELPL}	t _{CES}	$\overline{\text{CE}}$ Setup Time	2	—	μ s
t _{GLQV}	t _{OE}	Data Valid from $\overline{\text{OE}}$	—	150	ns

Notes:

- V_{CC} must be applied simultaneously or before V_{PP} and removed simultaneously or after V_{PP}.
- V_{PP} must be \geq V_{CC} during the entire programming and verifying procedure.
- When programming IS27HC010, a 0.1 μ F capacitor is required across V_{PP} and ground to suppress spurious voltage transients which may damage the device.
- Programming characteristics are sampled but not 100% tested at worst-case conditions.

PROGRAMMING ALGORITHM WAVEFORM^(1,2)

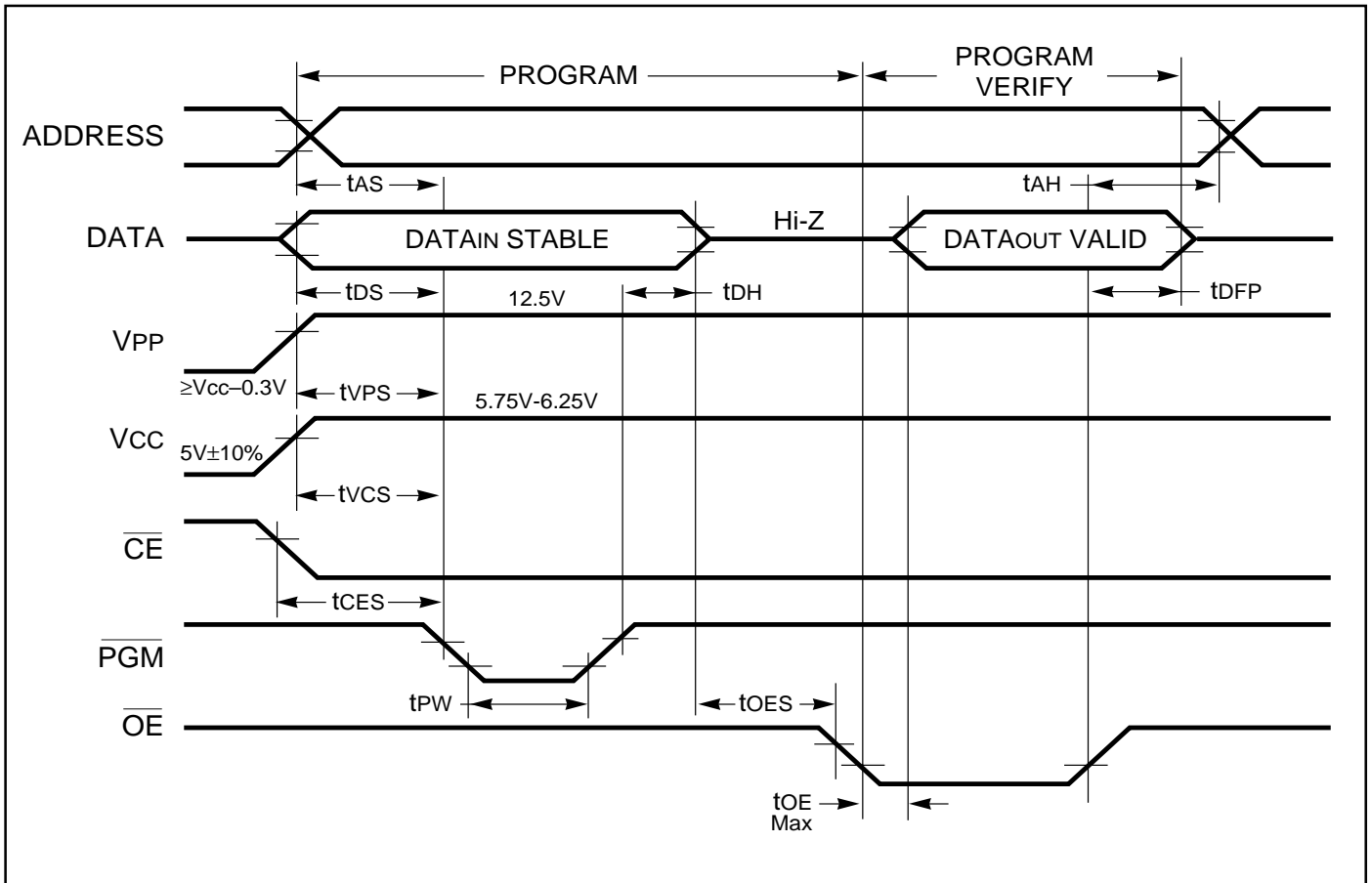

Notes:

1. The timing reference level is 1.5V for inputs and outputs.
2. t_{OE} and t_{DFP} are characteristics of the device but must be accommodated by the programmer.

PROGRAMMING FLOW CHART

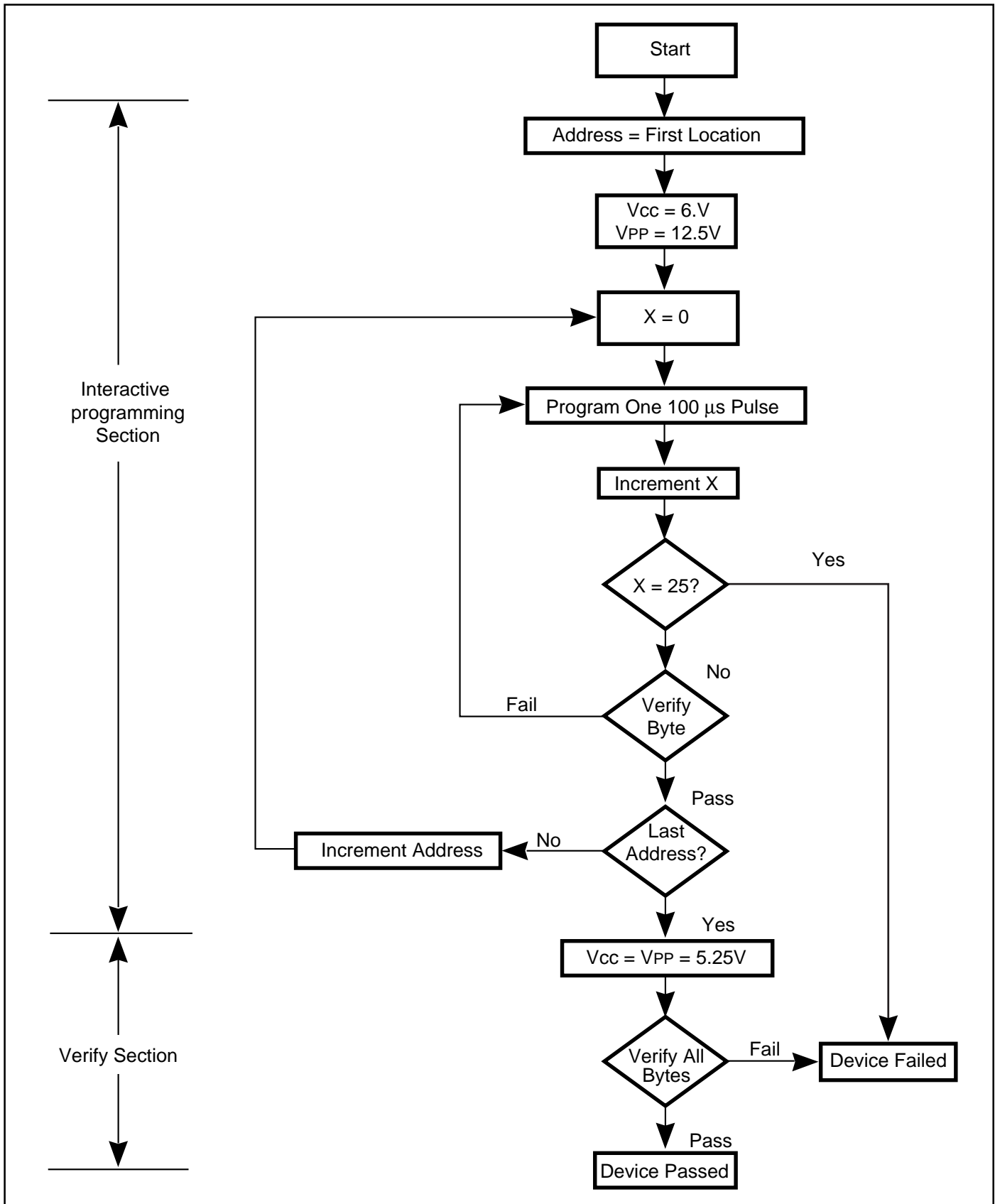

ORDERING INFORMATION**Commercial Range: 0°C to +70°C**

Speed (ns)	Order Part Number	Package
25	IS27HC010-25W	600-mil Plastic DIP
	IS27HC010-25PL	PLCC – Plastic Leaded Chip Carrier
	IS27HC010-25T	TSOP
30	IS27HC010-30W	600-mil Plastic DIP
	IS27HC010-30PL	PLCC – Plastic Leaded Chip Carrier
	IS27HC010-30T	TSOP
45	IS27HC010-45W	600-mil Plastic DIP
	IS27HC010-45PL	PLCC – Plastic Leaded Chip Carrier
	IS27HC010-45T	TSOP
70	IS27HC010-70W	600-mil Plastic DIP
	IS27HC010-70PL	PLCC – Plastic Leaded Chip Carrier
	IS27HC010-70T	TSOP

ORDERING INFORMATION**Industrial Range: –40°C to +85°C**

Speed (ns)	Order Part Number	Package
30	IS27HC010-30PLI	PLCC – Plastic Leaded Chip Carrier
	IS27HC010-30TI	TSOP
45	IS27HC010-45PLI	PLCC – Plastic Leaded Chip Carrier
	IS27HC010-45TI	TSOP
70	IS27HC010-70PLI	PLCC – Plastic Leaded Chip Carrier
	IS27HC010-70TI	TSOP